

WARNING! SHUT POWER OFF AT FUSE OR CIRCUIT BREAKER

HANGING THE FIXTURE (Fig.1)

1. Carefully remove the new fixture from the carton and the yellow bag that holds all parts. Check that all parts are included as shown in the illustration and parts list.
2. Shut off the power at the circuit breaker and remove old fixture from ceiling, including the old mounting strap.
3. The Mounting Strap (B) contains several pairs of threaded holes, find the pair of holes that match the holes spacing in your fixture Canopy (D) and thread the Nipple (A) half way into the Fixture Mounting Strap (B).
4. Attach the Fixture Mounting Strap (B) to the Junction Box using the two Mounting Screws (C). Tighten the Screws (C) securely with screwdriver.
5. Adjust correct length of cable needed for hanging height. You may need to cut short the wire and reconnect with transformer refer original mode.

CONNECTING THE WIRES (Fig.2)

6. Attach the power supply wires to the fixture lead wires by connecting BLACK to BLACK (or SMOOTH) and WHITE to WHITE (or RIBBED).
7. Attach the GROUND wire (GREEN or COPPER) from the Junction Box and the fixture Ground wire to the green Ground Screw on the Mounting Bracket (B) or connect both wires together using the correct size of wire connectors.

NOTE: Twist the wires together in the same direction you twist the wire connector onto the wires.

8. Tuck these wire connections neatly into the Junction Box.

FINISHING THE INSTALLATION (Fig.3)

9. Raise Canopy (D) to the ceiling and secure in place by tightening the Deco Nut (F).
10. Install the light bulbs and crystals as per the fixture assembly sheet.

YOUR INSTALLATION IS NOW COMPLETE. TURN POWER ON AT TO THE JUNCTION BOX & TEST THE FIXTURE.

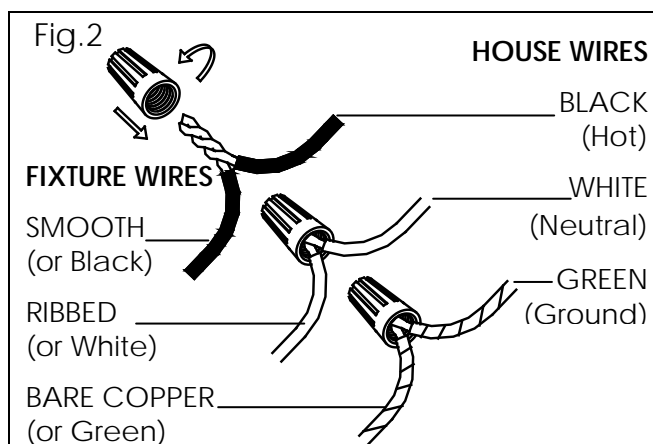
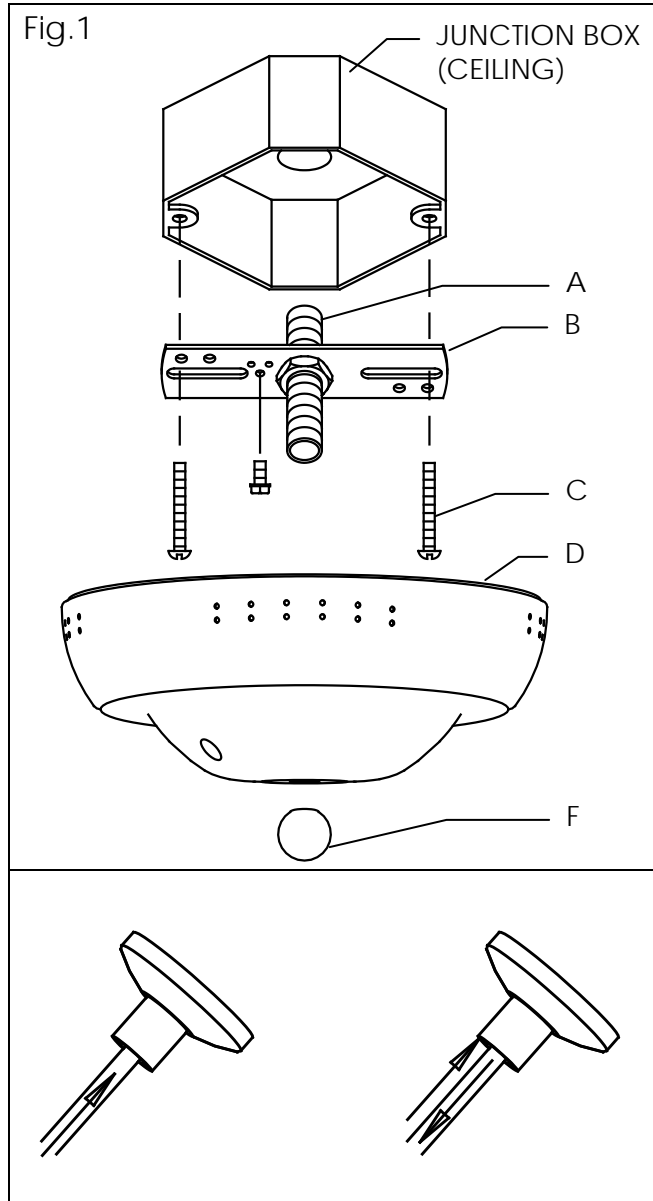

PARTS & ASSEMBLY SHEET







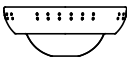

Fixture Name: AUTUMN TWILIGHT 9903-12 MG

This fixture assembled PO: _____ Date: _____

Notice: Please review the parts listing and check for all parts before assembling the fixture. If any parts are missing or damaged, please note on this sheet and contact the place of purchase to arrange for replacement parts.

PARTS LIST

Company Name: _____ Co Account#: _____
below to be filled out by retailer

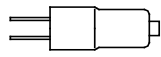
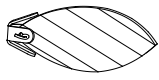
Canopy 1ea Φ175*H65 mm		Hex Nut 1ea NPS-1/4-18		Wire Connectors 3ea Orange	
Mounting Screws 2ea G8/32*H32 mm		Nipple 1ea NPS 1/4-18*85 mm		Deco Nut 1ea Φ19 mm	
Green Screw 1ea G8/32*H8 mm		Mounting Strap 1ea W103*H2.0 mm		Bulbs 12ea Halogen, Type G4 20W	
Crystal Leaf PT-CRYSTAL-9903 LEAF 76ea W27*H65 mm					

Part Needed _____ Quantity _____

Part Needed _____ Quantity _____

Reason why (missing, scratched, broken glass, bent, bad finish)

Comments _____

FIXTURE ASSEMBLY INSTRUCTIONS

Read and review installation instruction sheet before assembling the fixture

1. Open bag on the arm and carefully arrange the bead strings.
2. Screw Crystal Leaf (A) on the arm.
Hold carefully by the metal base to prevent the crystal from cracking.
3. Install the light bulbs in accordance with the fixture's specification.

Bulb note: Use a tissue or paper towel to hold the bulb and push down into socket. Oils or dirt can cause the bulb life to shorten. Rubbing alcohol is recommended to clean the bulbs if dirty.

(DO NOT EXCEED THE MAXIMUM WATTAGE RATING!)

9903-12 MG

Fig.3

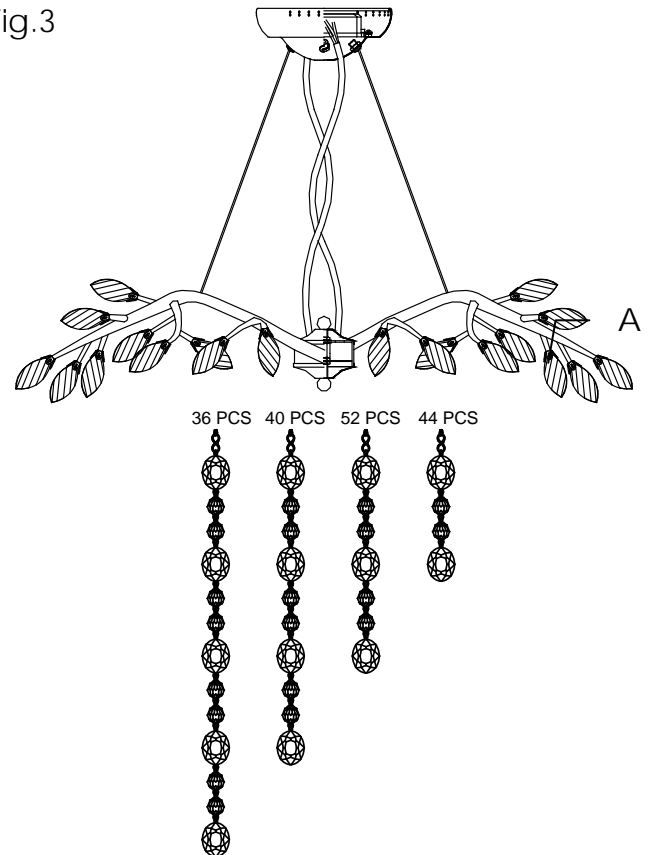

<p style="text-align: center;">9903-12 MG</p> <p>A -- PT-CRYSTAL-9903-2B B -- PT-CRYSTAL-9903-3B C -- PT-CRYSTAL-9903-4B D -- PT-CRYSTAL-9903-5B</p> <p style="text-align: center;">Each arm requires</p>	<p style="text-align: center;">A</p>  <p style="text-align: center;">X11</p>	<p style="text-align: center;">B</p>  <p style="text-align: center;">X13</p>	<p style="text-align: center;">C</p>  <p style="text-align: center;">X10</p>	<p style="text-align: center;">D</p>  <p style="text-align: center;">X9</p>
---	---	---	---	--

